

**SINGLE SUPPLY VOLTAGE, HIGH SPEED,
WIDE BAND, QUAD OPERATIONAL AMPLIFIERS**

The μ PC4744 is quad high speed, wide band operational amplifier designed for single supply operation from +3 V to +32 V with low supply current drain. By using high speed PNP transistors for input and output circuits, the excellent AC performance is achieved without degrading capacitive load drive capability.

With no crossover distortion and wide output voltage range characteristics, the μ PC4744 is optimum choice for single supply AC amplifier, and active filters.

FEATURES

- High slew rate: 8.5 V/ μ s TYP. ($V^+ = +5$ V, $V^- =$ GND)
- Wide gain band width product: 3.5 MHz TYP. ($V^+ = +5$ V, $V^- =$ GND)
- Wide supply voltage range: +3 V to +32 V
- Wide output voltage swing
- Common mode input voltage range includes V^-
- Internal frequency compensation
- Output short circuit protection

EQUIVALENT CIRCUIT (1/4 Circuit)

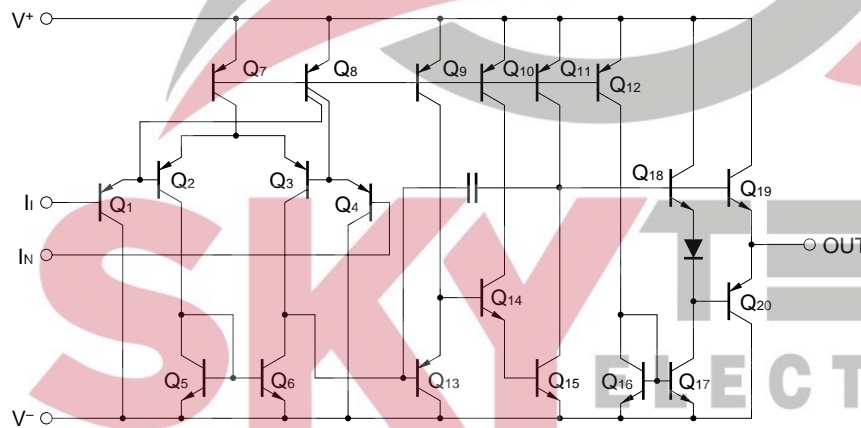

**PIN CONFIGURATION
(Top View)**

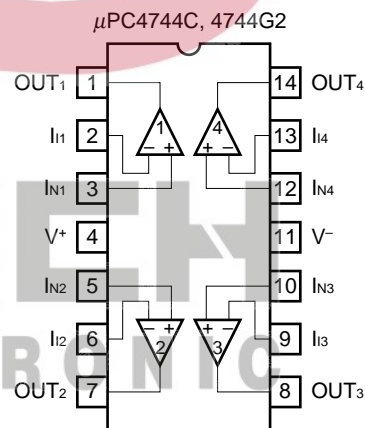

ORDERING INFORMATION

Part Number	Package
μ PC4744C	14-pin plastic DIP (300 mil)
μ PC4744G2	14-pin plastic SOP (225 mil)

The information in this document is subject to change without notice.

ABSOLUTE MAXIMUM RATINGS (T_A = 25 °C)

Parameter	Symbol	Ratings	Unit
Voltage between V ⁺ and V ⁻ Note 1	V ⁺ -V ⁻	-0.3 to +36	V
Differential Input Voltage	V _{ID}	±36	V
Input Voltage Note 2	V _I	V ⁻ -0.3 to V ⁻ +36	V
Output Voltage Note 3	V _O	V ⁻ -0.3 to V ⁺ +0.3	V
Power Dissipation	C Package Note 4	570	mW
	G2 Package Note 5		
Output Short Circuit Duration Note 6		Indefinite	sec
Operating Ambient Temperature	T _A	-20 to +80	°C
Storage Temperature	T _{stg}	-55 to +125	°C

- Notes**
1. Reverse connection of supply voltage can cause destruction.
 2. The input voltage should be allowed to input without damage or destruction independent of the magnitude of V⁺. Either input signal should not be allowed to go negative by more than 0.3 V. The normal operation will establish when the both inputs are within the Common Mode Input Voltage Range of electrical characteristics.
 3. This specification is the voltage which should be allowed to supply to the output terminal from external without damage or destructive. Even during the transition period of supply voltage, power on/off etc., this specification should be kept. The output voltage of normal operation will be the Output Voltage Swing of electrical characteristics.
 4. Thermal derating factor is -7.6 mW/°C when operating ambient temperature is higher than 50 °C.
 5. Thermal derating factor is -5.5 mW/°C when operating ambient temperature is higher than 25 °C.
 6. Pay careful attention to the total power dissipation not to exceed the absolute maximum ratings, Note 4 and Note 5.

RECOMMENDED OPERATING CONDITIONS

Parameter	Symbol	MIN.	TYP.	MAX.	Unit
Supply Voltage (Split)	V [±]	±1.5		±16	V
Supply Voltage (V ⁻ = GND)	V ⁺	+3		+32	V
Output Current	I _O			±10	mA
Capacitive Load (A _v = +1, R _f = 0 Ω)	C _L			1000	pF

ELECTRICAL CHARACTERISTICS (T_A = 25 °C, V[±] = ±15 V)

Parameter	Symbol	Conditions	MIN.	TYP.	MAX.	Unit
Input Offset Voltage	V _{IO}			±1.0	±6.0	mV
Input Offset Current	I _{IO}			±6	±75	nA
Input Bias Current ^{Note 7}	I _B			140	500	nA
Large Signal Voltage Gain	A _V	R _L ≥ 2 kΩ, V _O = ±10 V	25000	300000		
Supply Current	I _{CC}	I _O = 0 A, All Amplifiers		7.5	11	mA
Common Mode Rejection Ratio	CMR		70	86		dB
Supply Voltage Rejection Ratio	SVR		70	93		dB
Output Voltage Swing	V _{OM}	R _L ≥ 10 kΩ	±13.7	+14 -14.3		V
Output Voltage Swing	V _{OM}	R _L ≥ 2 kΩ	±13.5			V
Common Mode Input Voltage Range	V _{ICM}		V ⁻		V ⁺ -1.8	V
Slew Rate (Rise)	SR	A _V = 1, R _L ≥ 2 kΩ		8.5		V/μs
Gain Band Width Product	GBW	f _o = 100 kHz		3.5		MHz
Channel Separation		f = 20 Hz to 20 kHz		120		dB

ELECTRICAL CHARACTERISTICS (T_A = 25 °C, V⁺ = 5 V, V⁻ = GND)

Parameter	Symbol	Conditions	MIN.	TYP.	MAX.	Unit
Input Offset Voltage	V _{IO}			±1.0	±5	mV
Input Offset Current	I _{IO}			±6	±75	nA
Input Bias Current ^{Note 7}	I _B			160	500	nA
Large Signal Voltage Gain	A _V	R _L ≥ 2 kΩ	25000	300000		
Supply Current	I _{CC}	I _O = 0 A, All Amplifiers		6.0	9.0	mA
Common Mode Rejection Ratio	CMR		70	80		dB
Supply Voltage Rejection Ratio	SVR		70	95		dB
Output Voltage Swing	V _{OM}	R _L ≥ 2 kΩ (Connect to GND)	3.7 0	4.0 0		V
Common Mode Input Voltage Range	V _{ICM}		0		V ⁺ -1.8	V
Output Current (SOURCE)	I _{O SOURCE}	V ⁺ _{IN} = +1 V, V ⁻ _{IN} = 0 V	10	30		mA
Output Current (SINK)	I _{O SINK}	V ⁺ _{IN} = 0 V, V ⁻ _{IN} = +1 V	10	30		mA
Slew Rate (Rise)	SR	A _V = 1, R _L ≥ 2 kΩ		8.5		V/μs

Notes 7. Input bias currents flow out from IC. Because each currents are base current of PNP-transistor on input stage.

TYPICAL CHARACTERISTICS ($T_A = 25\text{ }^\circ\text{C}$, TYP.)

POWER DISSIPATION

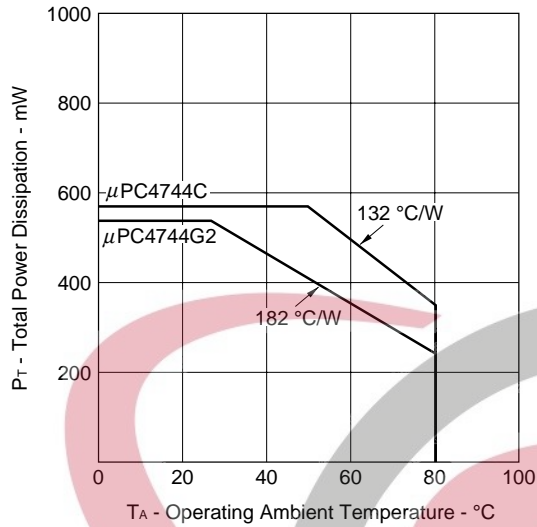

SUPPLY CURRENT

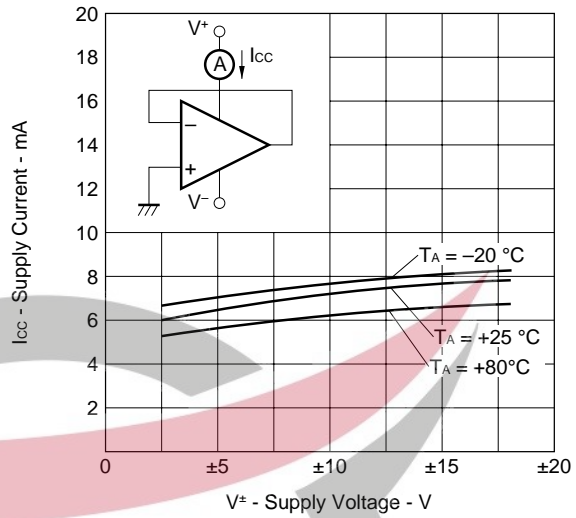

INPUT OFFSET VOLTAGE

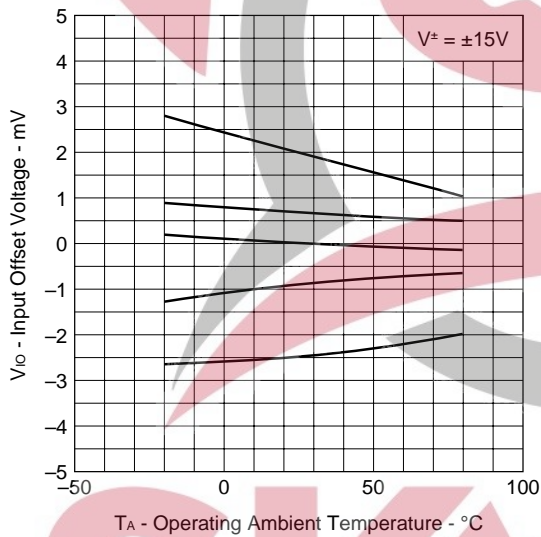

COMMON MODE INPUT VOLTAGE RANGE

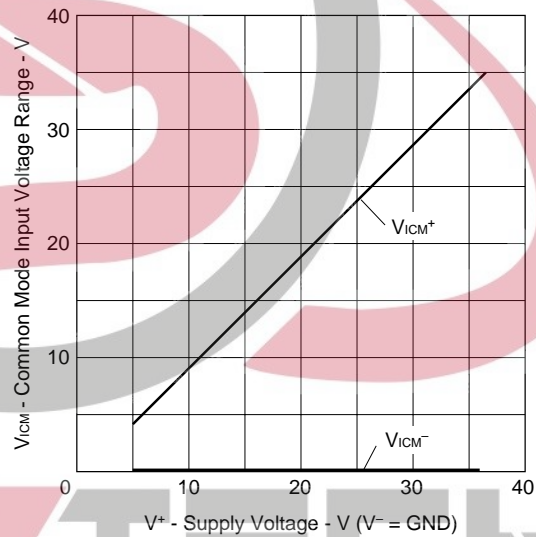

INPUT BIAS CURRENT

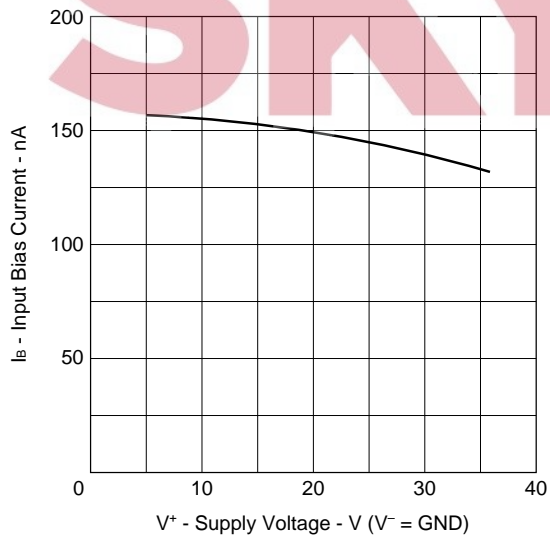

INPUT BIAS CURRENT

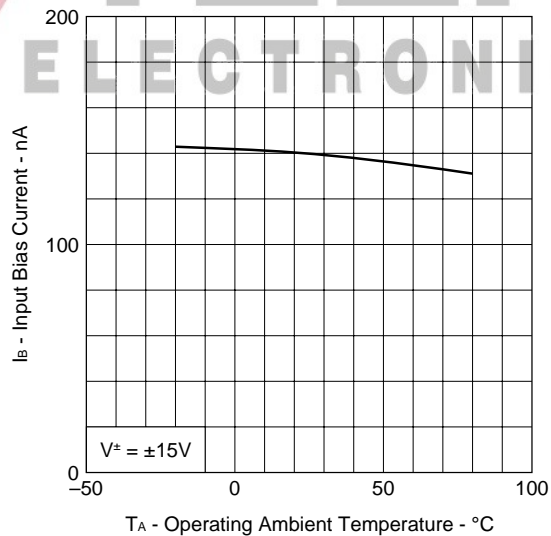

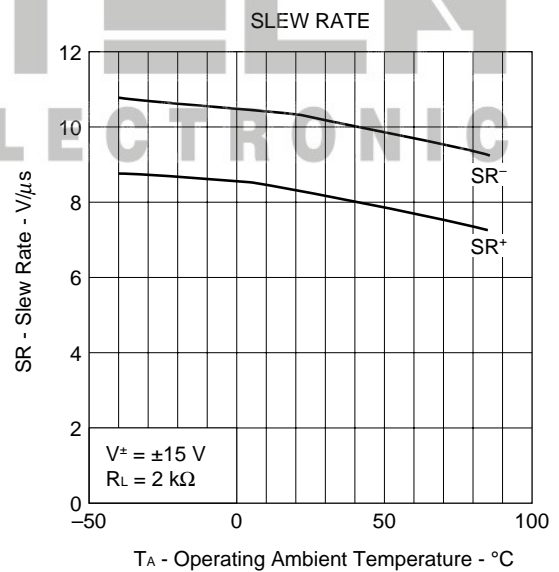
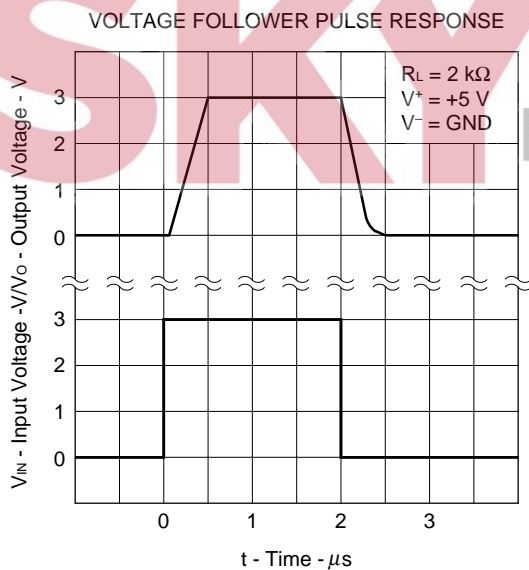
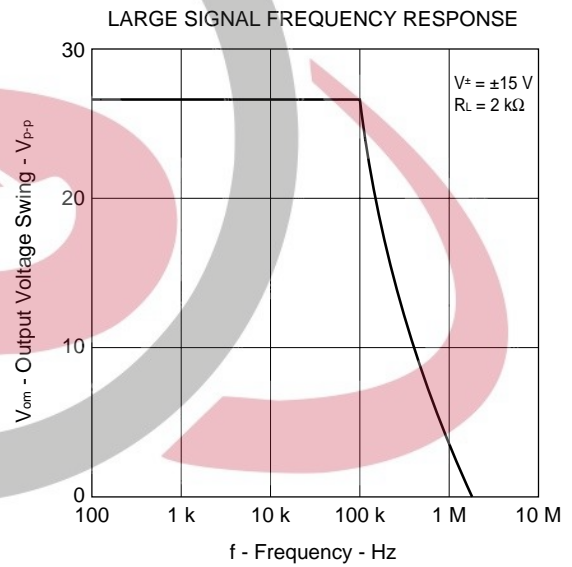
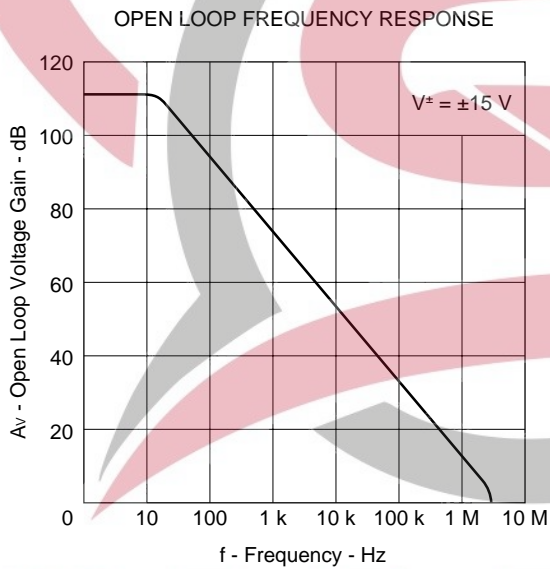
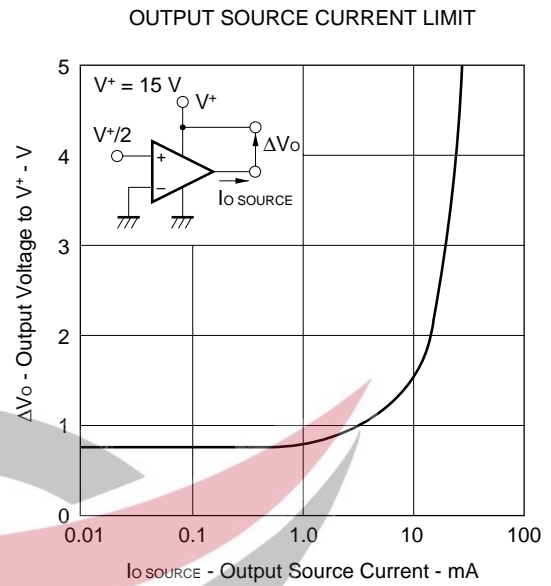
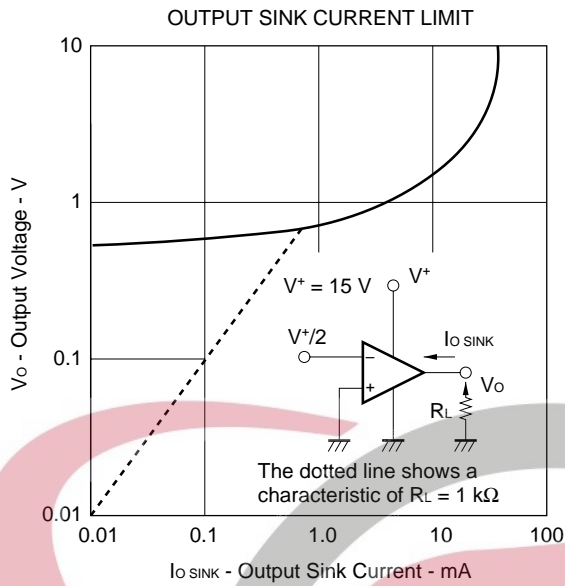

PACKAGE DRAWINGS

14PIN PLASTIC DIP (300 mil)

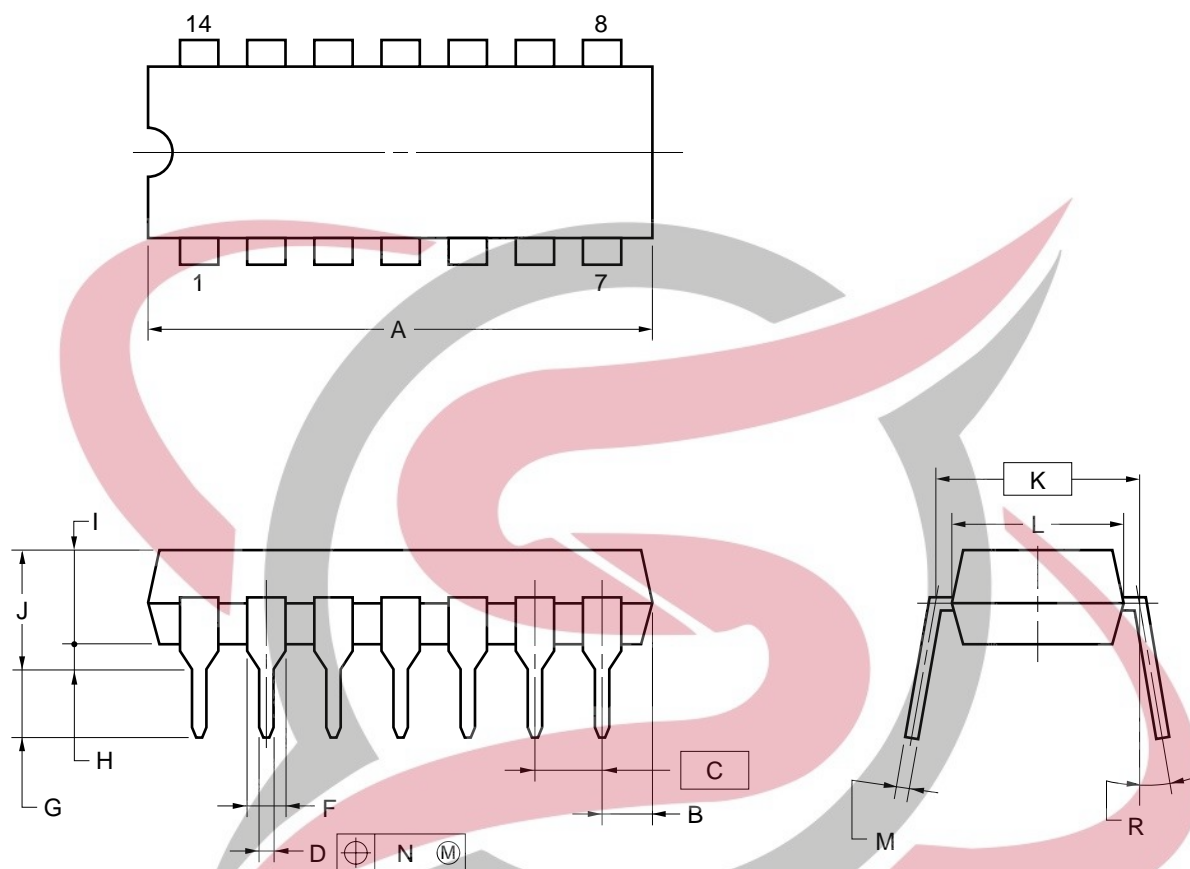

NOTES

- 1) Each lead centerline is located within 0.25 mm (0.01 inch) of its true position (T.P.) at maximum material condition.
- 2) Item "K" to center of leads when formed parallel.

ITEM	MILLIMETERS	INCHES
A	20.32 MAX.	0.800 MAX.
B	2.54 MAX.	0.100 MAX.
C	2.54 (T.P.)	0.100 (T.P.)
D	0.50±0.10	0.020 ^{+0.004} _{-0.005}
F	1.1 MIN.	0.043 MIN.
G	3.5±0.3	0.138±0.012
H	0.51 MIN.	0.020 MIN.
I	4.31 MAX.	0.170 MAX.
J	5.08 MAX.	0.200 MAX.
K	7.62 (T.P.)	0.300 (T.P.)
L	6.5	0.256
M	0.25 ^{+0.10} _{-0.05}	0.010 ^{+0.004} _{-0.003}
N	0.25	0.01
R	0~15°	0~15°

P14C-100-300B2-1

14 PIN PLASTIC SOP (225 mil)

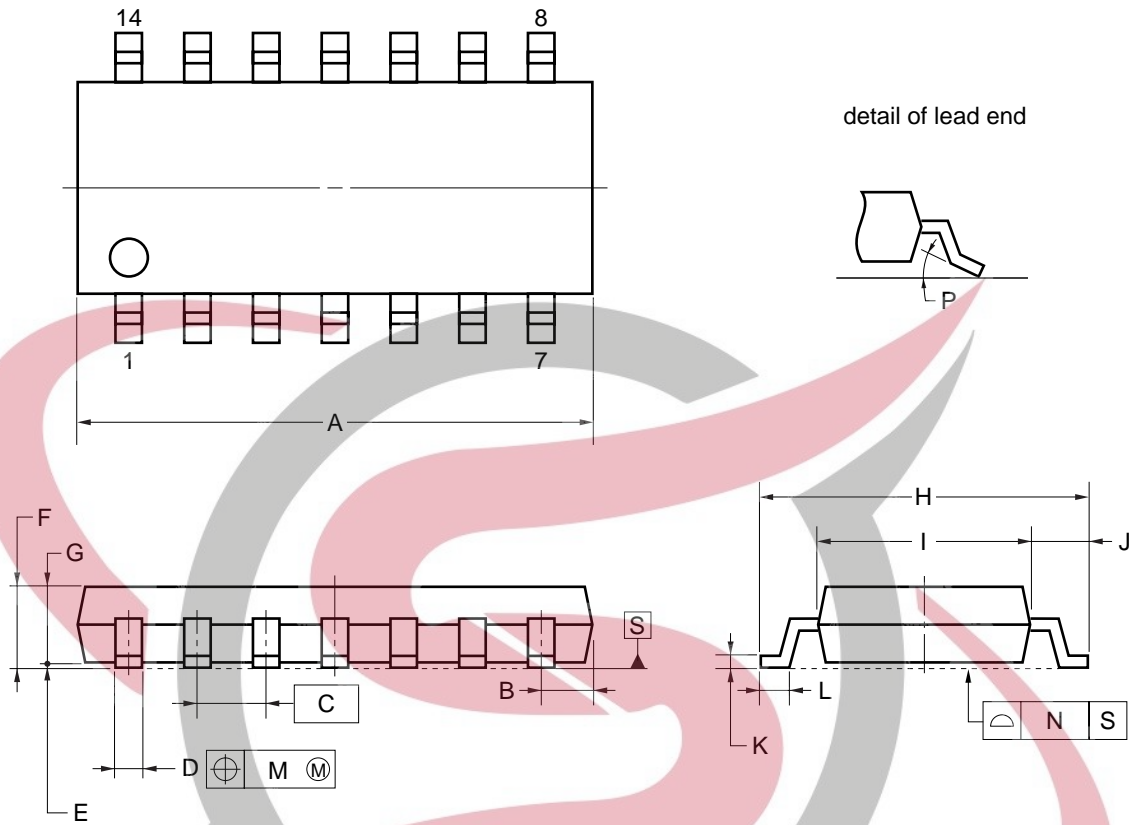

NOTE

Each lead centerline is located within 0.12 mm of its true position (T.P.) at maximum material condition.

ITEM	MILLIMETERS
A	10.2±0.26
B	1.42 MAX.
C	1.27 (T.P.)
D	0.42 ^{+0.08} _{-0.07}
E	0.1±0.1
F	1.59 ^{+0.21} _{-0.2}
G	1.49
H	6.5±0.2
I	4.4±0.1
J	1.1±0.16
K	0.17 ^{+0.08} _{-0.07}
L	0.6±0.2
M	0.1
N	0.10
P	3° ^{+7°} _{-3°}

S14GM-50-225B, C-5

SKYTECH ELECTRONIC

RECOMMENDED SOLDERING CONDITIONS

When soldering this product, it is highly recommended to observe the conditions as shown below. If other soldering processes are used, or if the soldering is performed under different conditions, please make sure to consult with our sales offices.

For more details, refer to our document “Semiconductor Device Mounting Technology Manual” (C10535E).

Type of Surface Mount Device

μPC4744G2: 14-pin plastic SOP (225 mil)

Process	Conditions	Symbol
Infrared Ray Reflow	Peak temperature: 230 °C or below (Package surface temperature), Reflow time: 30 seconds or less (at 210 °C or higher), Maximum number of reflow processes: 1 time.	IR30-00-1
Vapor Phase Soldering	Peak temperature: 215 °C or below (Package surface temperature), Reflow time: 40 seconds or less (at 200 °C or higher), Maximum number of reflow processes: 1 time.	VP15-00-1
Wave Soldering	Solder temperature: 260 °C or below, Flow time: 10 seconds or less, Maximum number of flow processes: 1 time, Pre-heating temperature: 120 °C or below (Package surface temperature).	WS60-00-1
Partial Heating Method	Pin temperature: 300 °C or below, Heat time: 3 seconds or less (Per each side of the device).	—

Caution Apply only one kind of soldering condition to a device, except for “partial heating method”, or the device will be damaged by heat stress.

Type of Through-hole Device

μPC4744C: 14-pin plastic DIP (300 mil)

Process	Conditions
Wave Soldering (only to leads)	Solder temperature: 260 °C or below, Flow time: 10 seconds or less.
Partial Heating Method	Pin temperature: 300 °C or below, Heat time: 3 seconds or less (per each lead).

Caution For through-hole device, the wave soldering process must be applied only to leads, and make sure that the package body does not get jet soldered.

REFERENCE DOCUMENTS

QUALITY GRADES ON NEC SEMICONDUCTOR DEVICES	C11531E
SEMICONDUCTOR DEVICE MOUNTING TECHNOLOGY MANUAL	C10535E
NEC IC PACKAGE MANUAL (CD-ROM)	C13388E
GUIDE TO QUALITY ASSUARANCE FOR SEMICONDUCTOR DEVICES	MEI-1202
SEMICONDUCTORS SELECTION GUIDE	X10679E
NEC SEMICONDUCTOR DEVICE RELIABILITY/QUALITY CONTROL SYSTEM (STANDARD LINEAR IC)	IEI-1212



[MEMO]



[MEMO]



[MEMO]

No part of this document may be copied or reproduced in any form or by any means without the prior written consent of NEC Corporation. NEC Corporation assumes no responsibility for any errors which may appear in this document.

NEC Corporation does not assume any liability for infringement of patents, copyrights or other intellectual property rights of third parties by or arising from use of a device described herein or any other liability arising from use of such device. No license, either express, implied or otherwise, is granted under any patents, copyrights or other intellectual property rights of NEC Corporation or others.

While NEC Corporation has been making continuous effort to enhance the reliability of its semiconductor devices, the possibility of defects cannot be eliminated entirely. To minimize risks of damage or injury to persons or property arising from a defect in an NEC semiconductor device, customers must incorporate sufficient safety measures in its design, such as redundancy, fire-containment, and anti-failure features.

NEC devices are classified into the following three quality grades:

"Standard", "Special", and "Specific". The Specific quality grade applies only to devices developed based on a customer designated "quality assurance program" for a specific application. The recommended applications of a device depend on its quality grade, as indicated below. Customers must check the quality grade of each device before using it in a particular application.

Standard: Computers, office equipment, communications equipment, test and measurement equipment, audio and visual equipment, home electronic appliances, machine tools, personal electronic equipment and industrial robots

Special: Transportation equipment (automobiles, trains, ships, etc.), traffic control systems, anti-disaster systems, anti-crime systems, safety equipment and medical equipment (not specifically designed for life support)

Specific: Aircrafts, aerospace equipment, submersible repeaters, nuclear reactor control systems, life support systems or medical equipment for life support, etc.

The quality grade of NEC devices is "Standard" unless otherwise specified in NEC's Data Sheets or Data Books. If customers intend to use NEC devices for applications other than those specified for Standard quality grade, they should contact an NEC sales representative in advance.

Anti-radioactive design is not implemented in this product.